

# TOWING PRODUCTS

## INSTALLATION / OPERATION INSTRUCTIONS 3205/66069 WEIGHT DISTRIBUTING HITCH SYSTEM

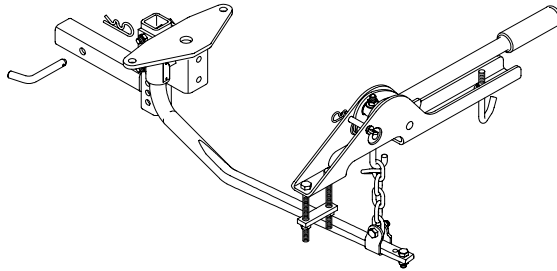

	MAX. TONGUE WEIGHT	MAX. GROSS TRAILER WEIGHT
RATING WHEN USED AS A WEIGHT DISTRIBUTING HITCH WITH SPRING BAR:	400 lb.	4,000 lb.
RATING WHEN USED AS A WEIGHT CARRYING BALL MOUNT WITHOUT SPRING BAR:	350 lb.	3,500 lb.

**DO NOT EXCEED TOWING VEHICLE MANUFACTURER'S LOAD RATINGS**

**DO NOT USE DUAL SWAY CONTROLS** (A single sway control can be installed on either left or right side.)

### INTRODUCTION

When a trailer is hitched to a tow vehicle, the tongue weight typically causes the rear of the tow vehicle to lower and the front to raise. See Figure 1.

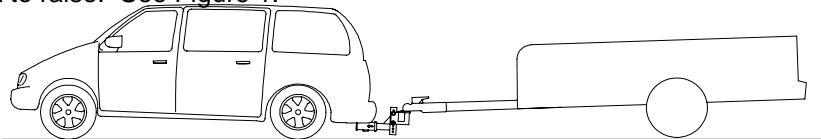

**Figure 1**

The purpose of a weight-distributing hitch is to remove excessive weight from the rear axle of the tow vehicle and distribute it to the front wheels and the trailer wheels. See Figure 2.

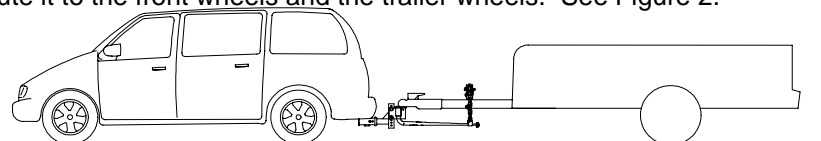

**Figure 2**

### SETUP DIMENSIONS

1. Line up tow vehicle and trailer on level pavement, in a straight-ahead position, uncoupled.
2. For vehicles with air springs, air shocks or automatic leveling systems, check vehicle owner's manual. Unless otherwise specified, level the vehicle with the vehicle loaded as it **will be** when towing. Deactivate load-leveling system before coupling trailer and adjusting spring bar.

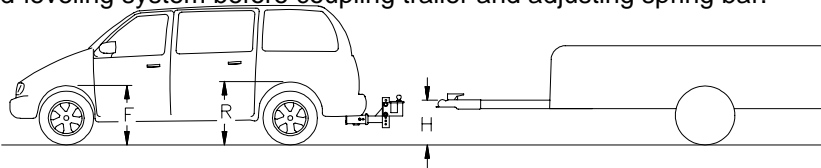

**Figure 3**

3. Measure and record uncoupled height on front and rear wheel openings to pavement and level trailer coupler height. See figure 3.

F = \_\_\_\_\_ R = \_\_\_\_\_ H = \_\_\_\_\_

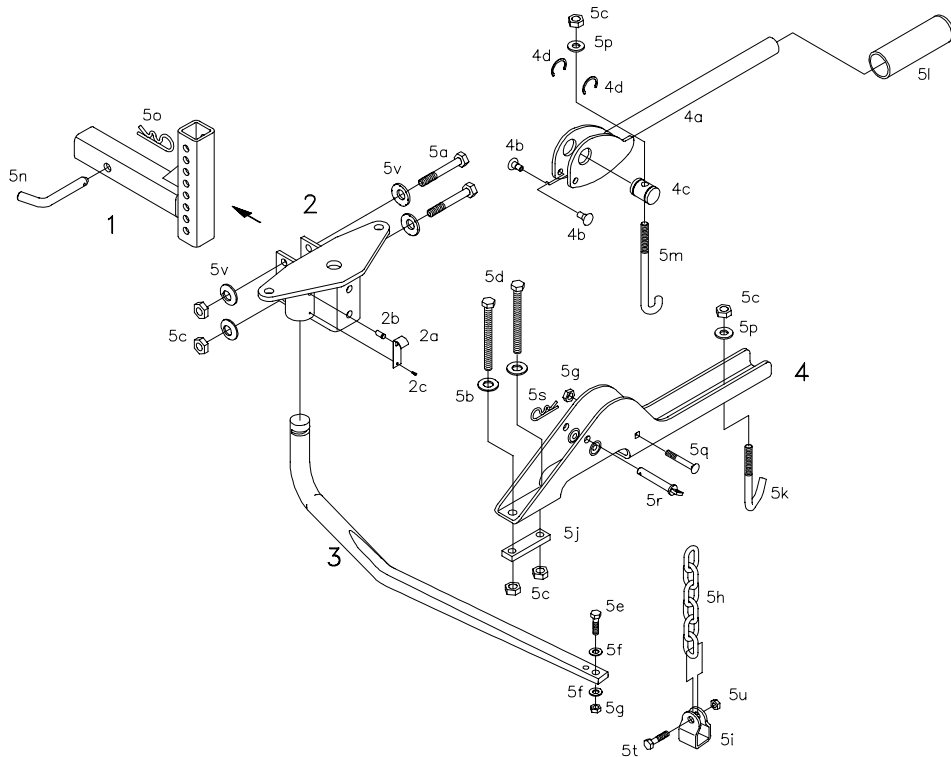

REF.	PART NUMBER	QTY.	DESCRIPTION
1	7470	1	Shank Assembly
2	6268	1	Head Assembly, Bolt Together
2a	*	1	Retainer
2b	*	1	Pin, Spring Bar Retaining
2c	*	1	Drive Screw
3	7660	1	Spring Bar
4	7400	1	Lift Unit Assembly
4a	7410	1	Handle Assembly
4b	3267	2	Rivet
4c	7411	1	Axle
4d	7418	2	Retaining Ring

REF.	PART NUMBER	QTY.	DESCRIPTION
5	F3205	1	Fastener Kit
5a	1150-016	2	Bolt, 1/2-13 x 4, Grade 5
5b	1160-008	2	Flat Washer, 1/2
5c	3376	6	Locknut, 1/2-13
5d	08473	2	Bolt, 1/2-13 x 6, Grade 5
5e	1145-005	1	Bolt, 3/8-16 x 1-1/4, Grade 5
5f	1160-006	2	Flat Washer, 3/8
5g	1243	2	Locknut, 3/8-16
5h	7413	1	Chain
5i	7414	1	Hanger
5j	7415	1	Bar

REF.	PART NUMBER	QTY.	DESCRIPTION
5k	7416	1	L-Bolt, 1/2-13
5l	7417	1	Grip
5m	7419	1	J-Bolt, 1/2-13
5n	1040**	1	Pin, Hitch 5/8
5o	1128**	1	Clip, Hair Pin
5p	3306	2	Flat Washer (Hardened)
5q	4224-012	1	Carriage Bolt, 3/8-16 Grade 5
5r	2210**	1	Pin, Hitch (Lock Pin 1)
5s	2209**	1	Clip, Hair Pin
5t	1147-006	1	Bolt, 7/16-14 x 1-1/2 Grade 5
5u	1213	1	Locknut, 7/16-14
5v	1292-008	4	Conical Toothed Washer

\* INCLUDED IN 3311 RETAINER KIT, INDIVIDUAL ITEMS NOT SOLD SEPARATELY

\*\* INCLUDED IN F3205 FASTENER KIT, ALSO SOLD SEPARATELY

**Figure 4**

**READ ALL INSTRUCTIONS AND CHECK PACKAGE CONTENTS**

**ASSEMBLE SYSTEM**

1. Insert shank into receiver and install pin and clip [See figure 4]. Shank (1) may be inserted in the upright or inverted position depending on uncoupled ball height [See figure 5].

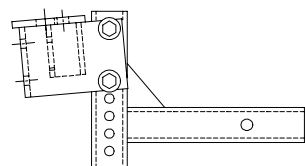
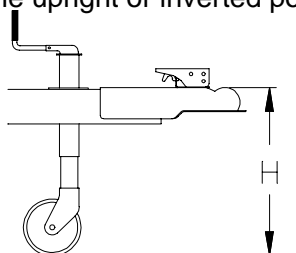

UPRIGHT POSITION

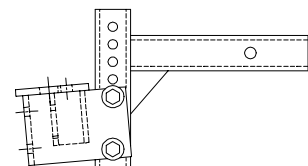

INVERTED POSITION

- Align head assembly bolt holes to the nearest holes on shank that corresponds to a ball height **approximately 1 to 1-1/2" higher** than trailer coupler height "H".

### TIGHTEN HEAD FASTENERS

- Tighten 1/2-13 GR5 bolts and locknuts to 75 lb. - ft. (Items 5a, 5v, & 5c – See figure 4)
- Assemble chain to spring bar hanger using 7/16-14 x 1-1/2" lg. hex bolt as shown in Figures 4 & 6. Chain must not bind [See figure 6].

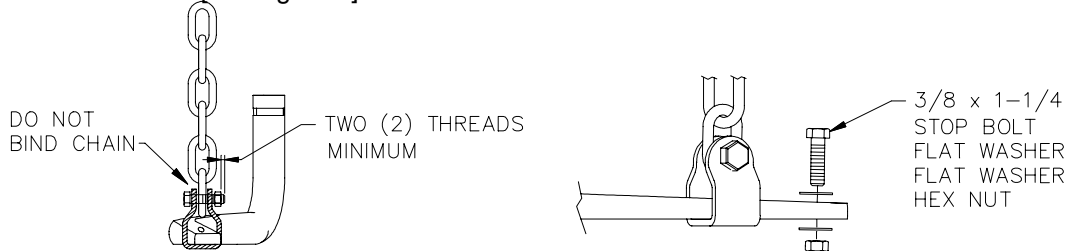
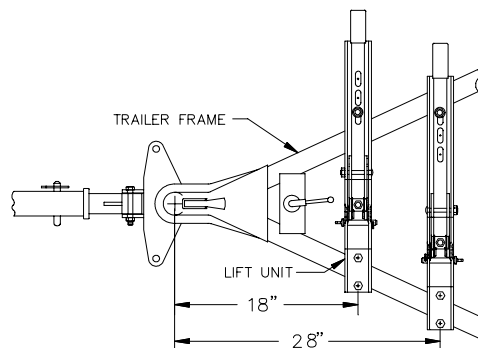

**Figure 6**

- Insert J-bolt through axle in handle assembly as shown in figure 4. Install 1/2 hardened flat washer and lock nut on top side. There must be three (3) threads minimum past the top of lock nut on J-bolt.
- Install 3/8 carriage bolt (item 5q) and lock nut in square holes in lift unit as shown in figure 4.  
NOTE: The threads of the carriage bolt must be pointing away from propane tanks if so equipped. Tighten 3/8-16 lock nut for carriage bolt until it contacts the Lift Unit - **DO NOT OVER TIGHTEN**.
- Install 3/8 x 1-1/4 Lg. stop bolt and flat washers in hole closest to the end of spring bar as shown in figures 4 & 6. Tighten 3/8-16 hex stop bolt to 31 ft lbs.
- Lower trailer coupler onto hitch ball and close coupler latch.

### INSTALL LIFT UNIT ASSEMBLY

- Place lift unit (4) on trailer "A" frame. The lift unit must be positioned 18" to 26" inches from center of trailer coupler and in orientation shown [See figures 7 & 8].



**Figure 7**

- Install the (2) two 1/2-13 x 6" lg. hex bolts and the L-bolt as shown in figure 8.  
Note: The L-bolt can be positioned on the inside or the outside of the trailer frame.
- Tighten 1/2-13 x 6" lg. Lift Unit mounting bolts and L-bolt to 25 ft lbs.
- Apply a heavy oil or grease (such as Hitch Ball Lubricant P/N 6939 or P/N 58117) to the upper grooved end of spring bar (3) on top surface and on vertical portion above bend.
- Line up spring bar (3) parallel to trailer frame on driver's side. Insert bar into head socket and push upward. A "click" will be heard when the retaining pin (2b) engages the spring bar groove.
- To remove spring bar, lift up on spring bar and gently pull out retainer (2a). Lower spring bar from head socket.

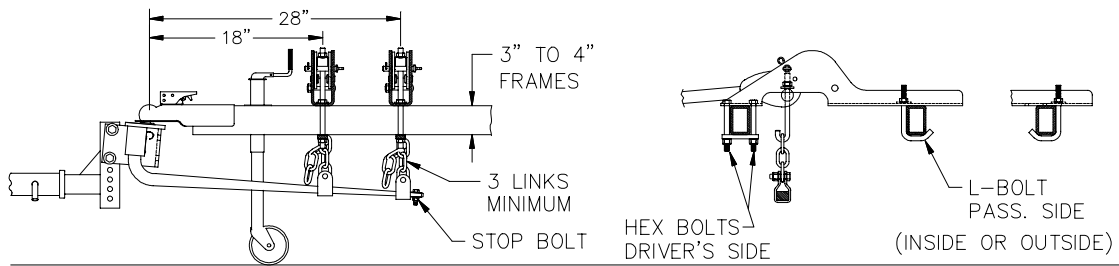

**Figure 8**

**SPRING BAR CHAIN CONNECTION**

1. With lift unit in lowered (Open) position, pull straight up firmly on spring bar chain. Note which link is closest to J-bolt hook [See figure 9].

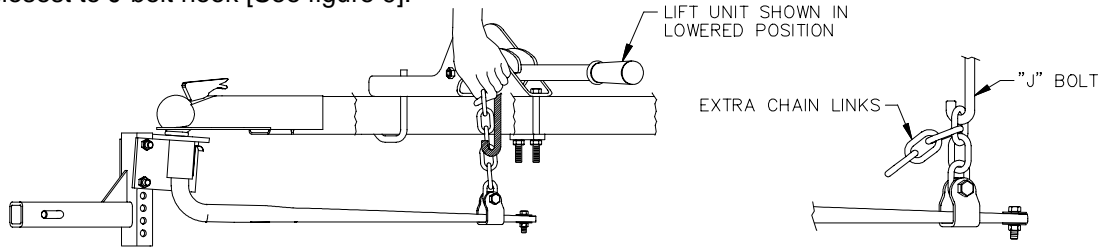

**Figure 9**

**NOTE: BEFORE OPERATING LIFT UNIT, RAISE BUMPER OF TOW VEHICLE WITH THE TRAILER TONGUE JACK . THIS WILL REDUCE SPRING BAR TENSION AND MAKE LIFT UNIT OPERATION EASIER.**

2. Attach upper end of chosen chain link to lift unit J-bolt, while allowing remaining free links to fall down [See figure 9].
3. **There must be at least 3 links between the lift unit and the spring bar.** This is necessary for proper operation of the spring bar during turns. **If there will be less than 3 links** between the lift unit and spring bar, adjust the J-bolt upwards.

**CAUTION: FAILURE TO CONNECT THE SPRING BAR CHAIN CORRECTLY AND PROVIDE AT LEAST 3 LINKS BETWEEN LIFT UNIT AND SPRING BAR CAN RESULT IN DAMAGE TO THE LIFT UNIT.**

4. Use handle to raise lift unit. **WARNING: Keep clear of all moving parts.**
5. Insert lock pin and spring clip on lift unit.
6. Retract trailer tongue jack so hitch is now carrying the full trailer weight.

**ADJUST HOOKUP (IF NECESSARY)**

A weight distributing system is properly set up and coupled when the tow vehicle has settled with the front wheel opening "F" at the original uncoupled dimension measured and slightly lower in the rear "R". See Figure 10.

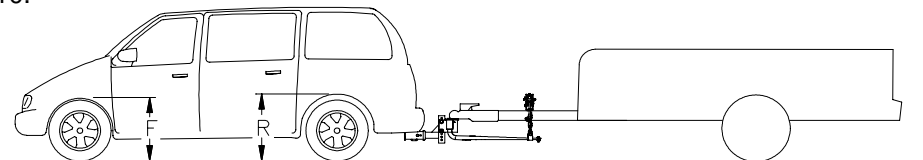

**Figure 10**

- This will assure the front wheel load remains unchanged. This results in good handling and the desired load on the rear axle and trailer axle.
- The front of the vehicle should never settle more than the rear. See Figure 11. If necessary increase the number of chain links between lift unit and spring bar.
- Mini-vans and small sport utility vehicles will typically settle with the front wheel opening "F" at the original dimension to 1/2" higher than original. This will still allow acceptable front wheel loads, good handling and the desired load on the rear axle and trailer axle.
- If the rear suspension sags too much, additional leveling is required. The front wheel opening "F" may **ONLY** be settled lower than the original dimension **IF** the rear wheel opening "R" has settled by a greater amount (At least 1").

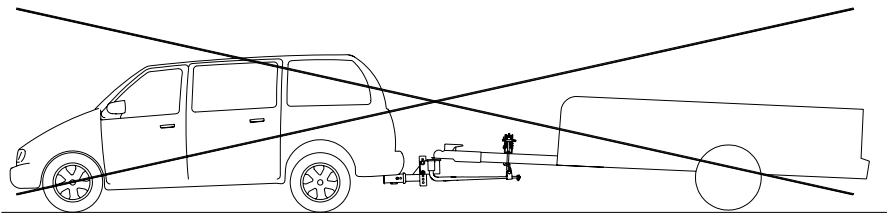

**Figure 11**

1. If additional leveling is required, decrease the number of chain links between lift unit and spring bar. If the system has been set to three (3) chain links and you have not achieved the desired leveling, thread hex nut farther onto the J-bolt as needed.
2. **There must be at least 3 links between the lift unit and the spring bar.** This is necessary for proper operation of the spring bar during turns. If there are less than 3 links, the J-bolt may be adjusted upwards.
3. When the desired settling is achieved, mark the hooked chain link with paint for future reference.

**NOTE:**

**SURGE BRAKES** usually require a small amount of fore-aft movement for their actuating mechanisms to function. To avoid restricting movement, it may be necessary to increase the number of chain links between the lift unit and the spring bar. **CHECK TRAILER AND/OR SURGE BRAKES OPERATING INSTRUCTIONS FOR SPECIAL REQUIREMENTS REGARDING WEIGHT DISTRIBUTING HITCHES.**

**CHECK ALL CONNECTIONS BEFORE TOWING**

1. Check the following: pin and clip securing shank to receiver, head to shank fasteners, ball nut, coupler latch, lift unit bolts, safety chains, lights and turn signals, and braking system, including breakaway switch.

**LUBRICATION**

1. **SPRING BAR AND HEAD SOCKET SHOULD BE LUBRICATED EACH TOWING DAY. FAILURE TO DO SO WILL RESULT IN EXCESSIVE SPRING BAR AND HEAD SOCKET WEAR.** Use a heavy oil or grease (such as Hitch Ball Lubricant P/N 6939 or P/N 58117).
2. Excessive oil, dirt, and grit should be wiped out of socket whenever trailer is uncoupled.
3. Clean hitch ball and coupler socket. Coat ball lightly with grease (such as Hitch Ball Lubricant P/N 6939 or P/N 58117).



**WARNING**

**FAILURE TO HEED MAY RESULT IN SERIOUS PERSONAL INJURY OR DEATH, VEHICLE CRASH, AND / OR PROPERTY DAMAGE**

---

**DO NOT USE TWO (2) FRICTION SWAY CONTROL UNITS ON THIS SYSTEM.**

**This unit is designed for only one (1) sway control device to be used on either side of trailer.**

**COUPLED BALL HEIGHT SHOULD NEVER BE GREATER THAN UNCOUPLED BALL HEIGHT.** Front wheel overload and loss of rear wheel traction can result. This can lead to unstable handling, reduced braking ability, and a tendency to “jackknife” when turning.

**USE EXTREME CAUTION WHEN BACKING UP AND TURNING. DO NOT ALLOW TOW VEHICLE AND TRAILER TO MANEUVER INTO A “JACKKNIFE” POSITION.** Components of the hitch and sway control, if applicable, may be forced into damaging contact. If a “jackknife” maneuver has occurred, examine all towing system components for damage or loosening immediately. Repair or replace any damaged components before resuming towing.

**DO NOT TOW MULTIPLE TRAILERS.** Towing multiple trailers may cause severe instability, loss of control and structural failure.

**DO NOT ATTEMPT TO HOOK-UP OR TOW WITH A FRONT WHEEL DRIVE VEHICLE WITH THE REAR WHEELS REMOVED.** This will cause severe instability, loss of control and structural failure.

## **TOWING TIPS**

**DRIVING** - Good habits for normal driving need extra emphasis when towing. The additional weight affects acceleration and braking, and extra time should be allowed for passing, stopping and changing lanes. Signal well before a maneuver to let other drivers know your intentions. Severe bumps and badly undulating road can damage your towing vehicle, hitch, and trailer, and should be negotiated at a slow, steady speed. **IF ANY PART OF YOUR TOWING SYSTEM "BOTTOMS OUT", OR IF YOU SUSPECT DAMAGE MAY HAVE OCCURRED IN ANY OTHER WAY, PULL OVER AND MAKE A THOROUGH INSPECTION. CORRECT ANY PROBLEMS BEFORE RESUMING TRAVEL.**

### **CHECK YOUR EQUIPMENT**

Periodically check the condition of all your towing equipment and keep it in top condition.

### **TRAILER LOADING**

Proper trailer loading is important. Heavy items should be placed close to the floor near the trailer axle. The load should be balanced side-to-side and firmly secured to prevent shifting. Tongue weight should be about 10 - 15 percent of the gross trailer weight for most trailers. Too low a percentage of tongue weight often produces a tendency to sway. Load the vehicles prior to set up.

### **SWAY CONTROL**

A sway control can help minimize the effects of sudden maneuvers, wind gusts and buffeting caused by other vehicles. Use of a sway control is recommended for trailers with large surface areas, such as travel trailers, and for trailers with low tongue weight percentage.

### **TIRE INFLATION**

Unless specified otherwise by the towing vehicle or trailer manufacturer, tires should be inflated to their maximum recommended pressure.

### **TOWING VEHICLE AND TRAILER MANUFACTURERS' RECOMMENDATIONS**

Review the owner's manual for your towing vehicle and trailer for specific recommendations, capacities, and requirements.

### **PASSENGERS IN TRAILERS**

Trailers should **NOT** be occupied while being towed, under any circumstances.

### **TRAILER LIGHT, TURN SIGNALS AND ELECTRIC BRAKES**

Always hook up trailer lights, turn signals, electric brakes and break-away switch connection (if equipped). Even for short trips.

**REMOVE HITCH HEAD WHEN NOT TOWING** - Remove hitch head from towing vehicle receiver when not towing. This will prevent contamination of head pockets, reduce chance of striking hitch head on driveway ramps or other objects, and minimize damage in event of a rear-end collision.

